

Sensor-Based Processing for Military & Aerospace



vadatech
THE POWER OF VISION

Leveraging Modular Open Systems Approach (MOSA)

VadaTech is a world leader in high performance embedded computing platforms and leverages its portfolio of innovative solutions to offer a large choice of platforms and data acquisition modules ideal for a range of applications. We use open standard platforms to minimize SWaP-C (Size, Weight, Power, and Cost) in your application, for modularity and scalability, and to lower your CAPEX, OPEX and risk. We focus on MicroTCA, AdvancedTCA and OpenVPX which are the standard MOSA platforms of choice.

At a time when product complexity and reliability demands are increasing, MOSA fosters open architectures that are generated and controlled through trade associations including PICMG and VITA. MOSA ensures reduced development expense, design cycle time and manufacturing cost. It creates:

- Efficiency by cutting acquisition/development cycle time, enhancing supportability and reducing life-cycle costs
- Closer cooperation between commercial and military electronics industries
- Interoperability and reuse of components among systems
- Access to cutting-edge technologies for rapid upgrades

- RADAR
- SIGINT/ELINT
- EW
- Communication Network
- Data Storage
- Simulators

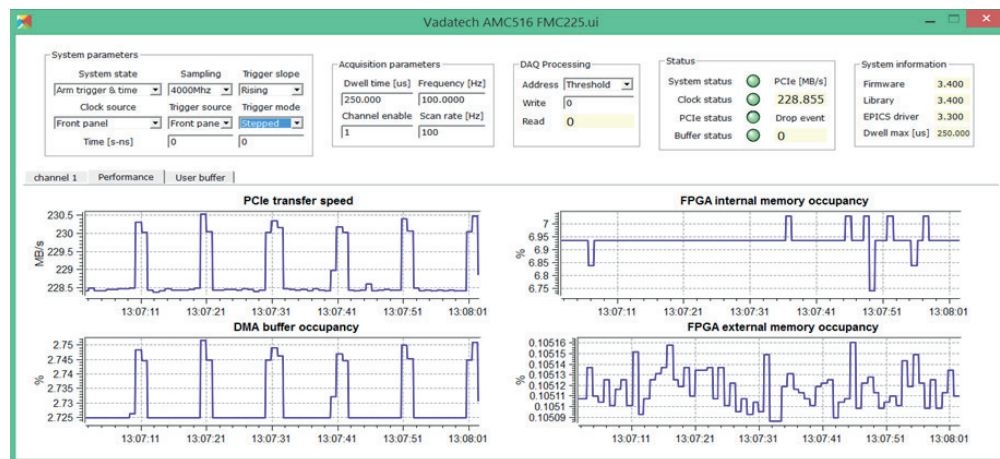

DAQ Series user interface is configurable and based on open standards



Deployed Systems

Small Form Factor

Land-mobile and UAV applications

- Compact, fully conduction-cooled
- Sensor processing from ADC to network
- Simple, flexible configuration choices



Rugged Rackmount

Land-mobile and sub-surface naval

- Network-centric processing sub-system
- Fast acquisition with precision timing
- Full platform management



Rackmount Microserver

Controlled and ground-fixed environments

- Compact, fully conduction-cooled
- Sensor processing from ADC to network
- Simple, flexible configuration choices



ATR

Fixed- and rotary-wing installations

- Rugged, fully conduction cooled
- System health monitoring
- Fast port from development to deployment



Rugged ATCA

Naval and wide-body airborne

- 40G networking
- High-end processing
- MIL-STD-810F/461E



VadaTech's world class leading high performance embedded computing solutions meet the high-reliability requirements of electronic warfare, communications, radar/sonar, simulators and other military & aerospace applications.

We have built a reputation for creating innovative solutions to our customers' business problems; whether they are technical challenges, time-to-market issues, life cycle management, or the need to completely outsource platform production. Our flexibility, technical strength, and ability to quickly engage both engineering and commercial functions, all help our customers to generate and seize new opportunities.

Applications

Radar

Land/Sea/Air
Full Receiver
Processing Chain



Sonar

Sea/Air
Dipping, Towed,
Hull-Mount

Signal Intelligence

Fixed/Mobile/UAV
Fully Integrated
Digital Receiver



Mission Computing

Command/Control
Network Centric
Situational Awareness

Other Mil/Aero Applications

Electronic Warfare • Communications
Network • Data Recorders • Simulators

A/D & D/A

VadaTech is a trusted supplier of SIGINT modules to global military and aerospace industry leaders. With the VITA57 FMC, you benefit from mechanical and electrical flexibility as well as interoperability. FMCs are integrated into the FPGA architecture of your choice. The AD/DA functions can also be directly integrated on the FPGA module. VadaTech selects each component to provide high RF performances from RF connector to AD/DA silicon.

Connect to your sensor or analog front-end and take advantage of a wideband capability in the VUHF frequency bands. Cover most licensed and unlicensed bands in your transceiver applications.



AMC526
AMC Dual ADC, Virtex-7, 12-Bit @ 2.6 GSPS



AMC529
AMC Dual DAC 14-bit @ 5.7 GSPS Module



AMC524
Quad ADC, 16-bit @ 125 MSPS, Dual DDS, Artix-7



FMC218
FMC High-speed DAC 14-bit at 2.5 GSPS



FMC228
FMC Quad ADC 12-bit @ 1 GSPS



FMC225
ADC, 12-bit @ 4.0 GSPS & DAC, 14-bit @ 5.7 GSPS



FMC226
FMC Dual ADC, 12-bit @ 4.0 GSPS

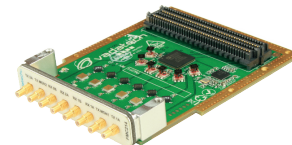

FMC214
FMC 70 MHz to 6 GHz Dual Versatile Wideband Transceiver

Specialty FMCs and Timing

Synchronization, reliability and compatibility are key factors when approaching the system level in land, airborne or navy application. VadaTech customers have been successful in adopting specialty FMCs and AMCs dedicated to timing and synchronization of remote systems.

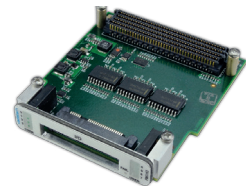

FMC153
8-Bit Synchronous NECL Output w/Clock



AMC005
AMC Time and Frequency with GPS and IRIG



FMC150
FMC IRIG-B Module

High Performance FPGA Carriers

- Selection of latest generation FPGA
- Designed for high performance signal processing
 - Compatible with DAQ Series' Signal Processing Development Kit
 - From 2GB to 20GB external memory
 - High speed PCIe Gen3 DMA engine
- Utilize virtual JTAG probe for remote programming and upgrade
- Distributed architecture with onboard PowerPC
- Flexible clock/trigger routing

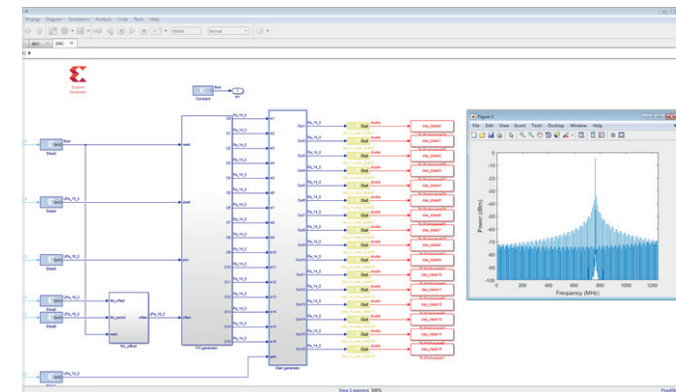

Save resources by coding FPGA with System Generator for DSP™ and Matlab Simulink™.

PCI516

PCIe FPGA Carrier for FMC, Virtex-7



FPGA Carriers

AMC517

Kintex-7 410T, 2GB DDR3, Freescale PPC2040

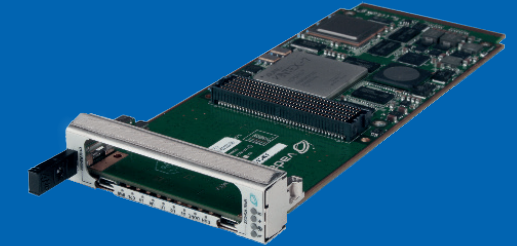

AMC516

Virtex-7 690T, 2GB DDR3, Freescale PPC2040



AMC592

Kintex UltraScale™ XCKU115, 20GB DDR4

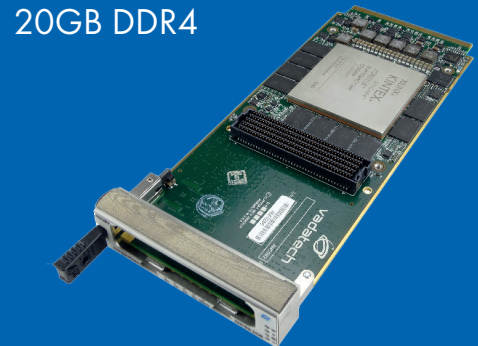

AMC593

Dual FMC Carrier, Kintex UltraScale™ XCKU115, Freescale PPC2040



Networking Storage IO PCIe/XMC/PMC Modular Building Blocks

Storage SATA & SSD in Raid 0, 1, 10



AMC624
2.5" Dual/Single
SATA III Drive 4TB

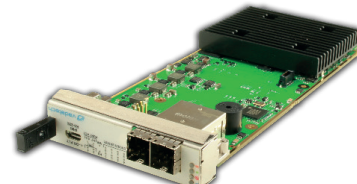

AMC628
Advanced RAID
(0, 1, 5, 6, 10, 50 & 60)

Optical Fiber FMCs for custom protocol network applications

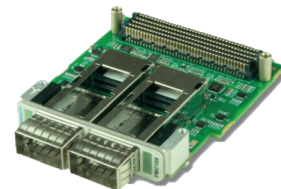

FMC108
Dual QSFP+

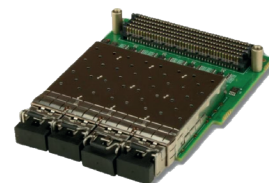

FMC109
Quad SFP+

XMC/PMC and PCIe carrier for Non MTCA form factor compatibility

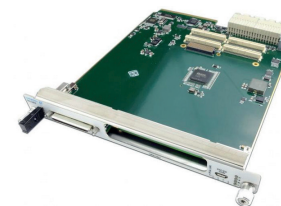

AMC105
XMC/PMC Carrier



PCI123
PCIe Gen3 Module
for PCIe Bus
Expansion

Digital and Serial IO for full control of your system



AMC095
16-channel Digital IO

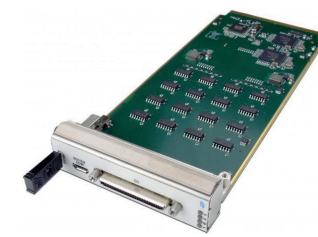

AMC323
Eight Port RS-422
Serial Adapter

Rugged MTCA.3

- Conduction cooled chassis and modules
- Hardware Platform Management
- The clamshell encases the functional AMC module in an electrically conductive shell providing ESD protection for a 15 kV half-inch ball test
- MTCA and VPX small form factor both use PWB edge pads for high speed interconnect
- MTCA.3 backplane connector system qualification test summary includes:
 - 50G mechanical shock
 - Random vibration/halt 12Grms, 50 -2kHz
 - Bench handling/vibration over temperature
 - Thermal cycling humidity
 - Insulation resistance
 - Dielectric withstanding voltage
 - Durability @ std environment
 - Engaging/separating force
 - Salt fog/SO₂ (2 days), salt fog
 - Sand and dust
 - 15kV ESD
 - MTCA 500 hours vs. VPX 250 hours
- MIL-CC2, MIL-CC3 and MIL-CC4 and based upon ANSI/VITA47, MIL-STD-810 requirements

	MTCA.0	MTCA.1	MTCA.3
Application Ruggedization Level	Telco/ Industrial (Telco-centric)	Extended Telco/ Industrial	Ext Telco/ Military (MIL-centric)
Max Operating Shock	15g	25g	40g
Max Operating Vibration	1g sinusoidal	8g random	12g random
Operating Temperature	-5C to +55C	-40C to +85C (XT1)	-40C to +85C (CC4)

MicroTCA Ruggedization Standard

Acquisition, Transmission & Storage

AMC526C

AMC Dual ADC, Virtex-7, 12-Bit @ 2.6 GSPS



AMC635

AMC Carrier for JBOD, 8 mSATA Disk

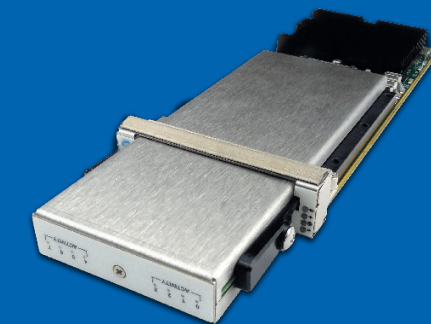

AMC720C

Xeon E3-1125 Processor AMC, PCIe



DAQ Series Software Package

Setup the clock and trigger source, set the acquisition sequence, visualize the acquisition and timestamping data in real time. Support your application long term with source code based on open standards.

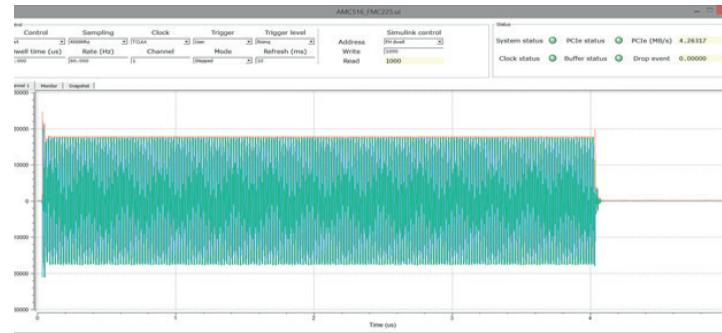

Setup your clock and trigger source, set your sequence and visualize the digitized data.

Modify the source code and GUI to match your application needs.

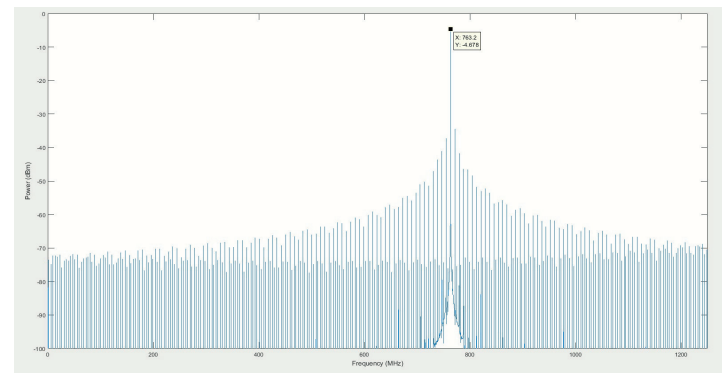

Simulation of PSK modulation. Develop your signal processing functions before you receive your hardware

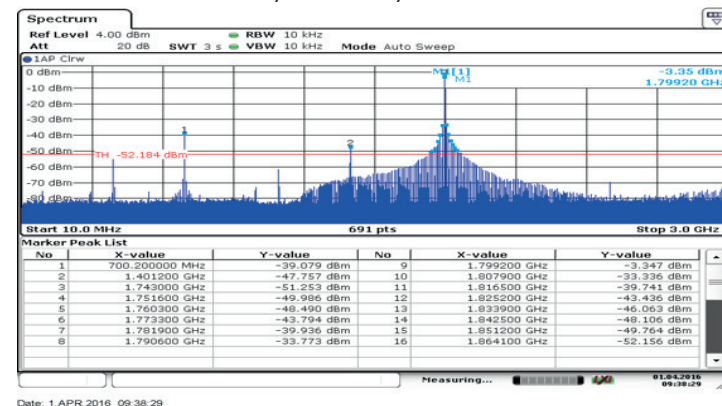

Load the IP created during the simulation phase into your FPGA project with DAQ Series. Visualize the result of PSK modulation on FMC225 and compare to the preliminary simulation results.

Complete solution

- Realtime acquisition, recording, display
- System control
- System status

Fast development / verification of custom signal processing algorithms

- Create your algorithms in MATLAB/Simulink
- Integrate your algorithms on FPGA with Xilinx System Generator

Highly customizable

- Open source
- Source code / netlists provided
- Common API for all VadaTech DAQ products

High performance

- Simultaneous acquisition / data transfer to Linux server
- From 2GB to 20GB on-board snapshot buffer
- High speed DMA transfer to Linux server

Real time system monitoring

- Buffer level
- PCIe speed
- Hardware status

High accuracy timestamping

- Slot-to-slot timestamp synchronization
- Nanosecond timestamp accuracy

Flexible acquisition sequencing

- Rising/falling trigger detection
- User defined trigger function
- Continuous/stepped triggering mode

Real time display

- Spectrum analyzer
- Oscilloscope

SIGINT

- High density acquisition platform: 7 ADC (4GSPS, 12bit), 1 DAC (2.8GSPS, 14 bits) in 1U chassis
- Large Signal Processing capabilities: 4 Virtex 7 FPGA with 8GB of DDR3
- High speed interconnect: 12GB/s DMA engine from FPGA to CPU
- High performance computing: Intel Broadwell DE, 32GB DDR4, RedHat, Fedora
- Flexible reference clock/trigger/timestamp capabilities
 - Front panel clock/trigger
 - GPS triggering and synchronized clock
 - Clock/trigger to all AMC through the backplane
 - PTP compatible
- Complete software solution
 - DAQ Series

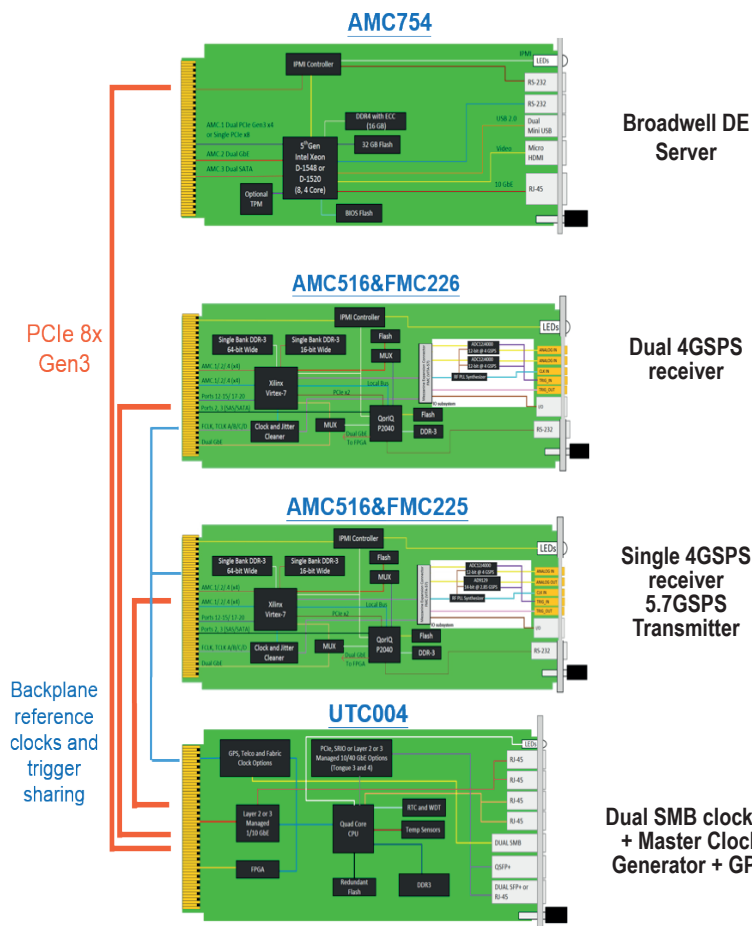

Synchronized multi-channel acquisition platform for VUHF

Fast implementation of FFT, filters, narrowband or wide band DDC in DAQ Series:

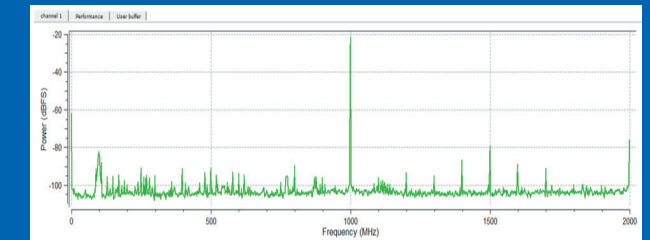

Spectrum analyzer display with FFT implementation in the DAQ Series

Pulse and Burst acquisition:

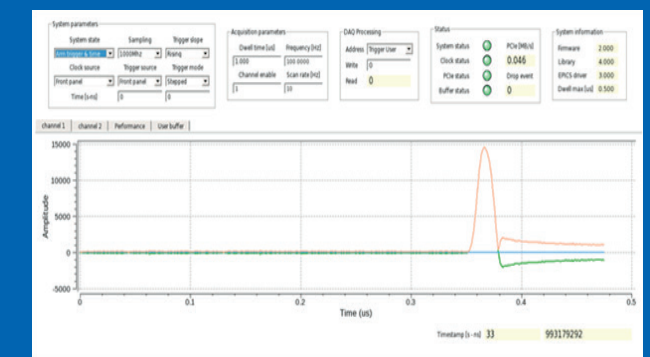

Acquisition and timestamping data display of 16ns pulse digitized with VadaTech FMC226

Electronic Warfare Subsystem



System Health Management

Military and aerospace systems integrators are leveraging Intelligent Platform Management Interface (IPMI) in open architectures such as VPX, AdvancedTCA (ATCA) and MicroTCA (MTCA) to improve their system performance while reducing costs.

The shelf manager monitors and controls the payload blades and other field replaceable units (FRUs) in a system, such as fans and power supplies. The shelf manager can take action or report a situation to the system manager, according to the rules set by the system designer.

As these standards were originally defined for the telecom industry, VadaTech has developed key features, which are typically not required in commercial environments, to address the harsh conditions faced by soldiers, sailors and pilots.

Shelf Manager

- Exchange commands and status with FRUs
- Manage system and FRU configuration
- Provide fault tolerance and hotswap control

Battle Short

- Temporary bypass of system safety thresholds
- Restore safety features after mission completion
- Prevents interruption during critical events

Cold Start

- System preheat used to prevent component damage
- System power-on based on temperature threshold
- Lower system costs with COTS components

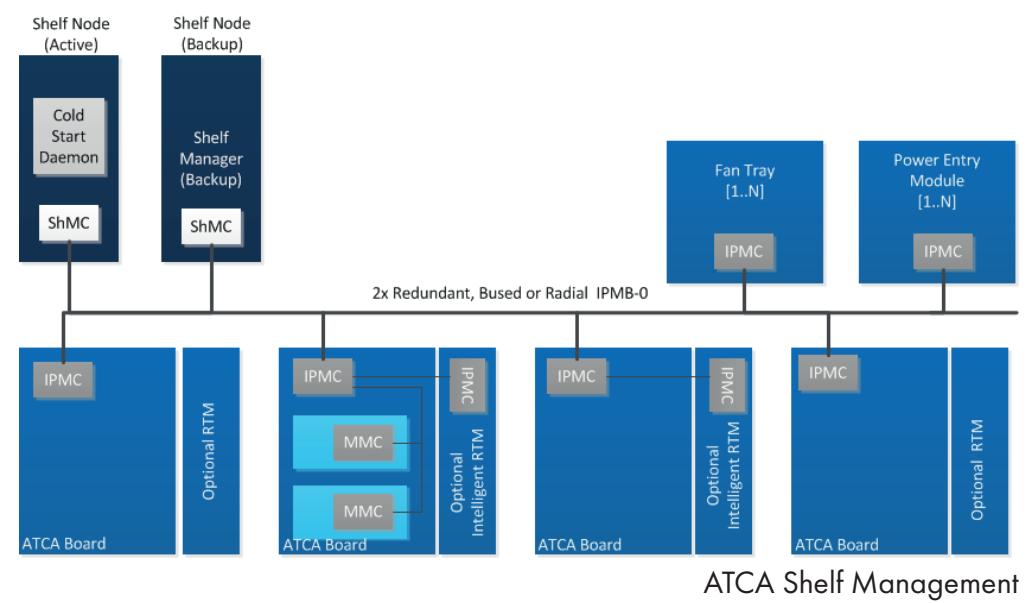
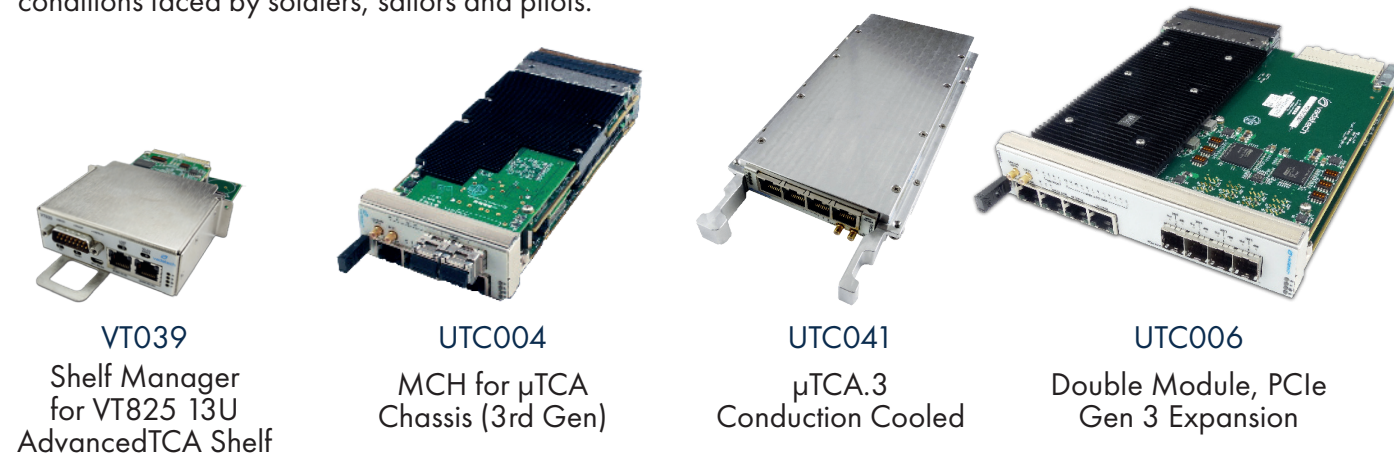

ATCA Shelf Management

About VadaTech

VadaTech is a dynamic company, pushing technology to new limits. Focused on embedded computing applications, our vision transforms technology into innovative solutions for a variety of markets. Rapidly evolving technologies require our customers to adopt open systems based hardware platforms to meet the demands of their markets which are many times uncertain and unstable thus demanding a nimble response. With a focus based on VITA and PICMG open standards, we offer unmatched product selection and expertise, especially in the areas of data acquisition, signal processing, rugged systems, and other cutting edge embedded technologies.

At VadaTech, we differentiate ourselves from other embedded computer manufacturing companies by incorporating our customers' vision into the product specification and development process; all the way through to deployment. Our partnership philosophy with our customers expands their engineering resources, increasing their value and reducing their time to market.

Throughout each project, we work closely with our clients to ensure that a high level of support and communication is provided from development through to successful deployment. Our collaborative approach to product development enables us to share 'the power of vision' with our customers.

Quality and Service

Our products are assembled and tested in our USA headquarters to guarantee the best quality and reliability.



Our integration team is dedicated to collaborate and guide you from platform concept to the acceptance and validation of your deployed system.



Contact

VadaTech Corporate Office

198 N. Gibson Road
Henderson, NV 89014
+1 702 896-3337

Asia Pacific Sales Office

7 Floor, No. 2, Wenhua Street
Neihu District, Taipei
114, Taiwan
+886-2-2627-7655

VadaTech European Sales Office

VadaTech House, Bulls Copse Road
Totton, Southampton
SO40 9LR United Kingdom
+44 2380 016403

info@vadatech.com | www.vadatech.com

Choose VadaTech

We are technology leaders

- First-to-market silicon
- Continuous innovation
- Open systems expertise

We commit to our customers

- Partnerships power innovation
- Collaborative approach
- Mutual success

We deliver complexity

- End-to-end Processing
- System management
- Configurable solutions

We manufacture in-house

- Agile production
- Accelerated deployment
- AS9100 accredited



vadatech
THE POWER OF VISION

XILINX
ALLIANCE PROGRAM
CERTIFIED